

Typ A

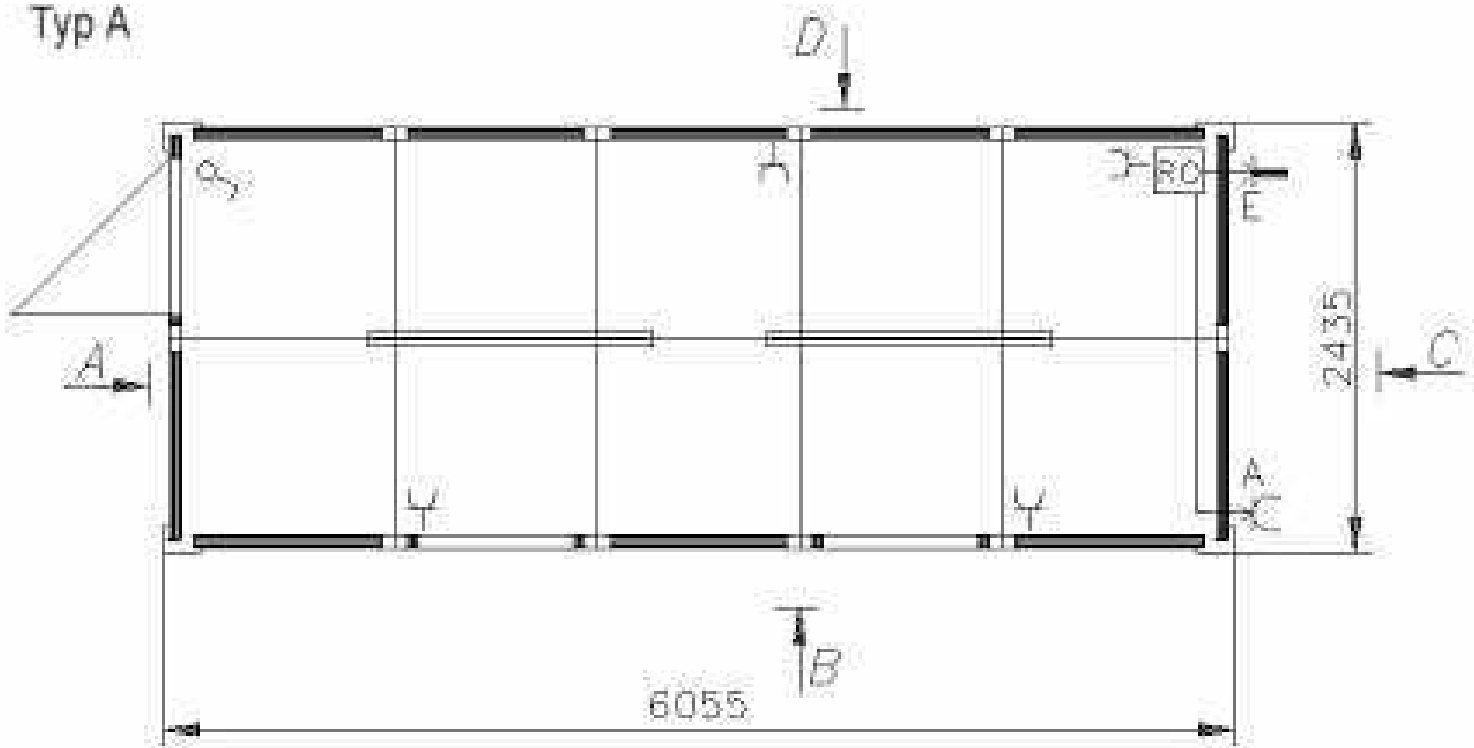

Ansicht A



Ansicht B

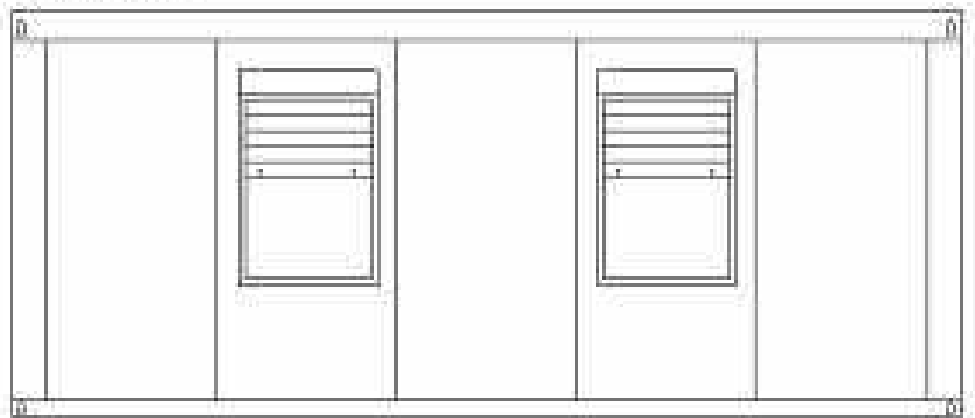

Ansicht C

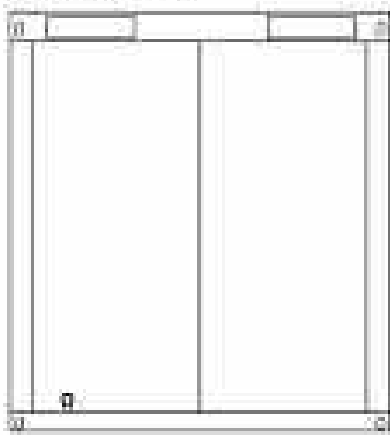

Ansicht D

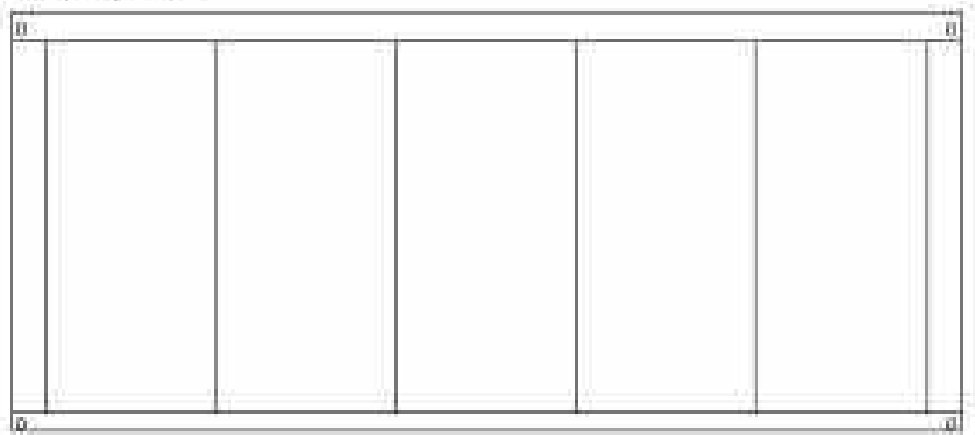

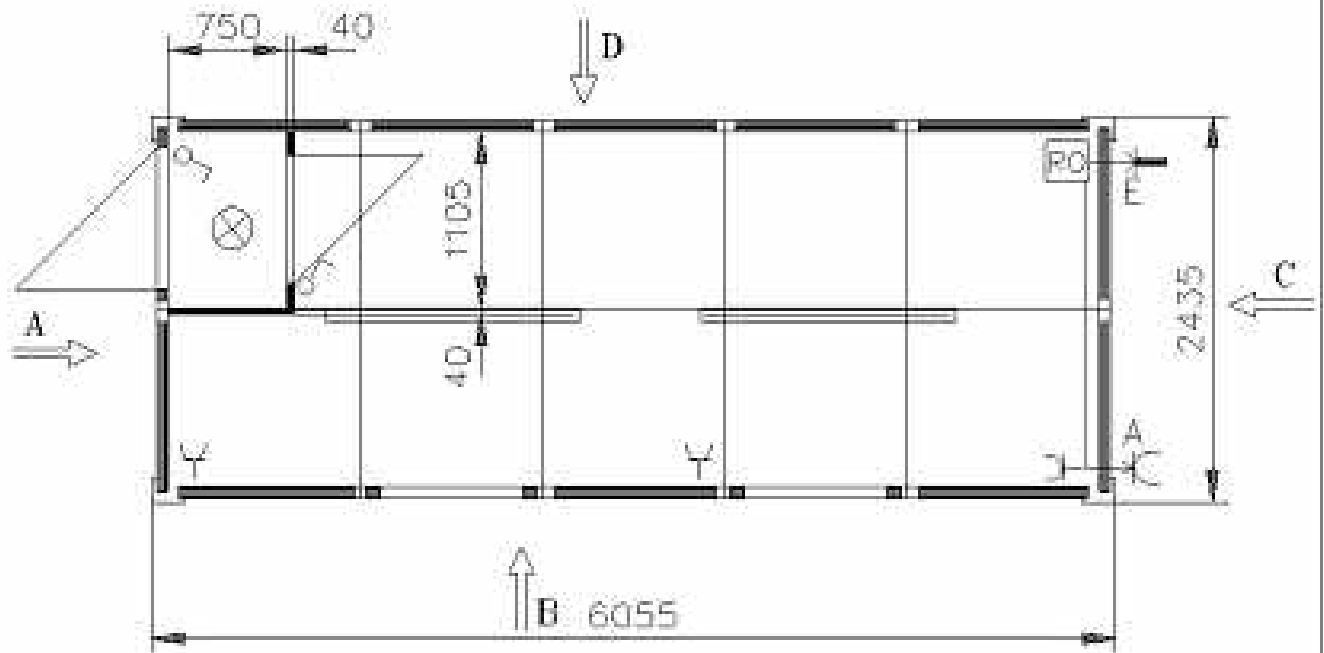

Ansicht A

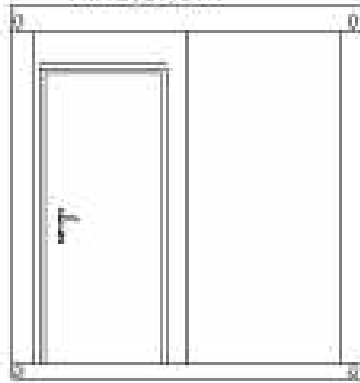

Ansicht B

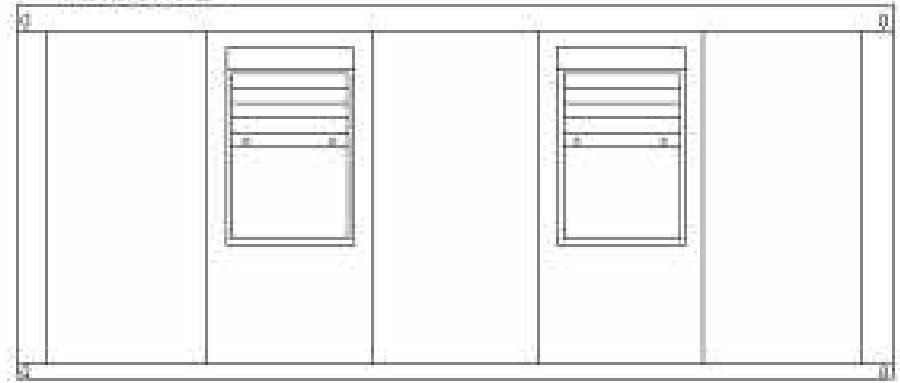

Ansicht C

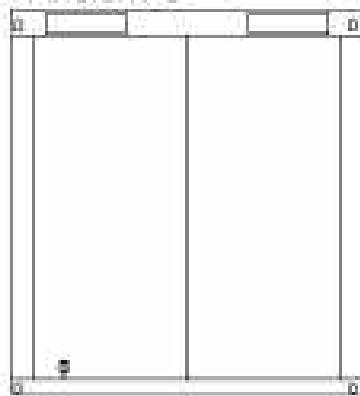

Ansicht D

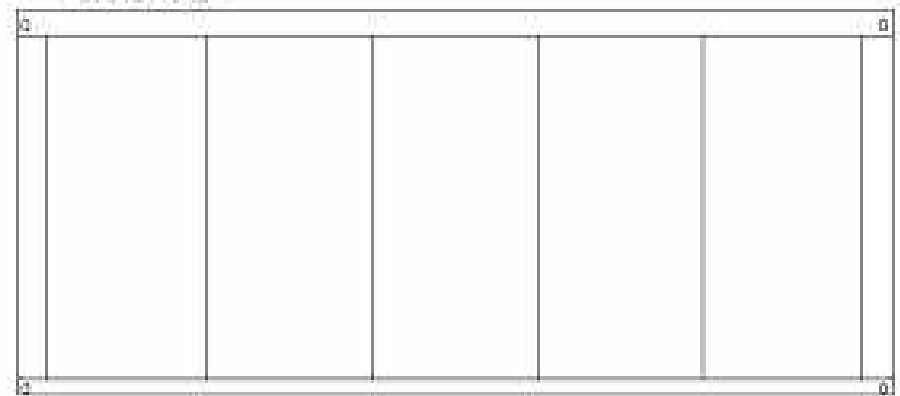

TYP-B

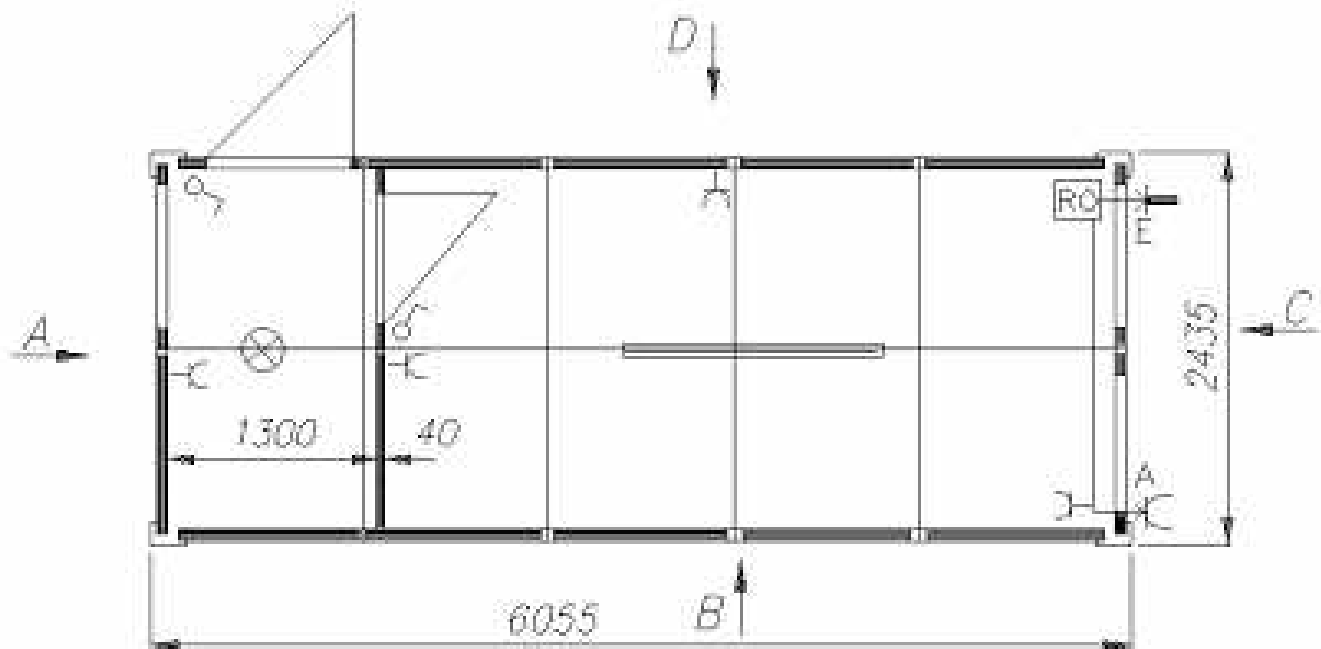

Ansicht A

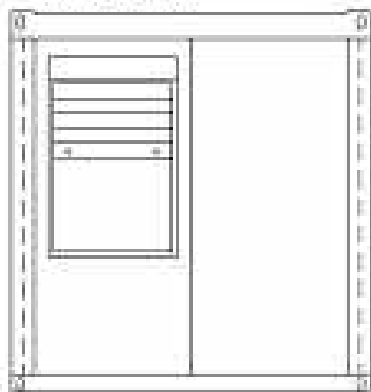

Ansicht B

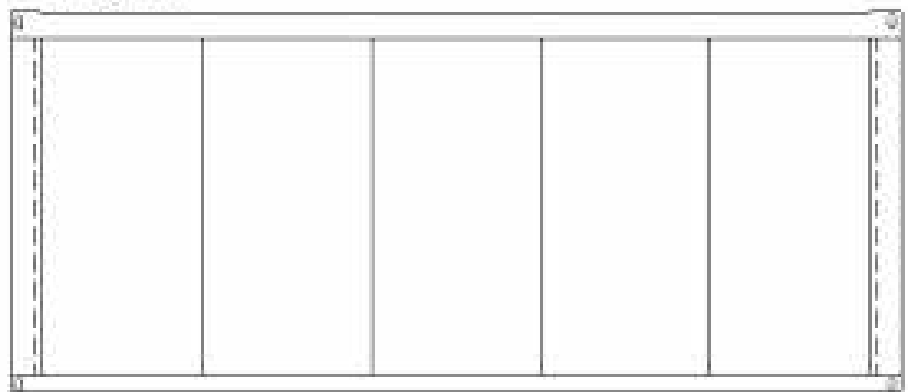

Ansicht C

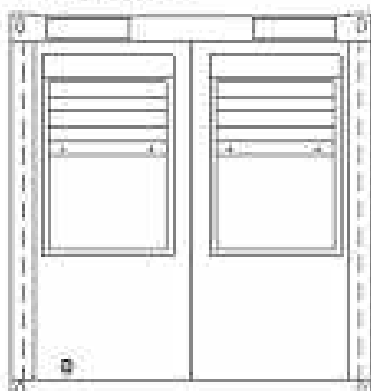

Ansicht D

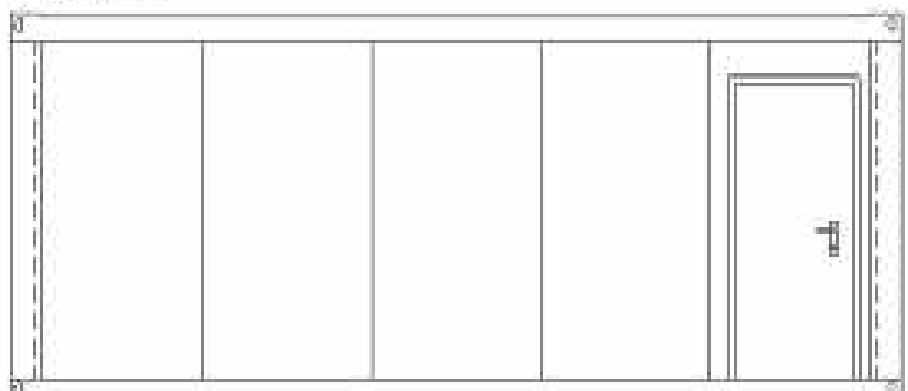

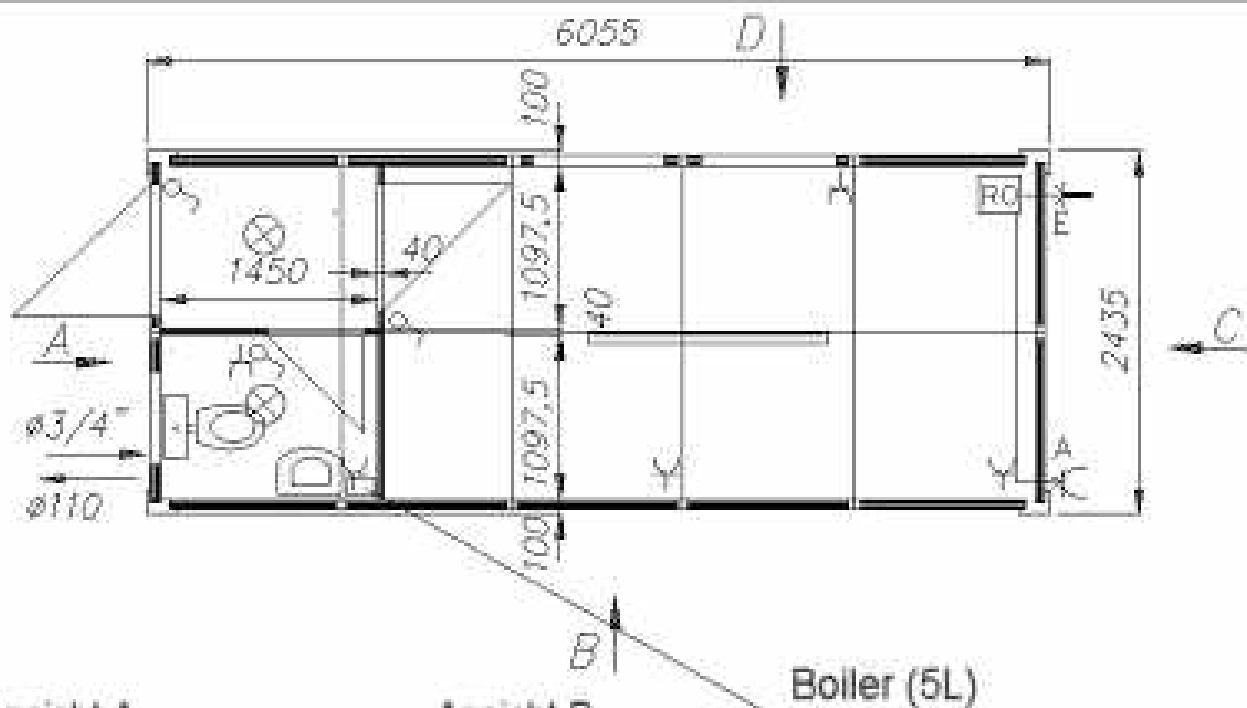

Ansicht A

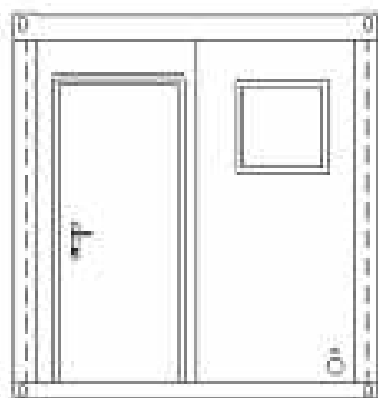

Ansicht B

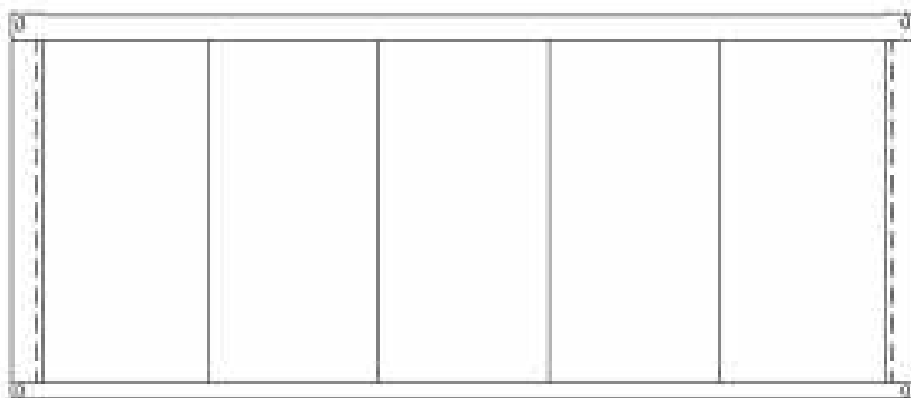

Ansicht C

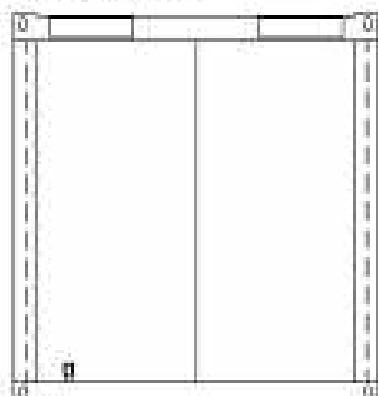

Ansicht D

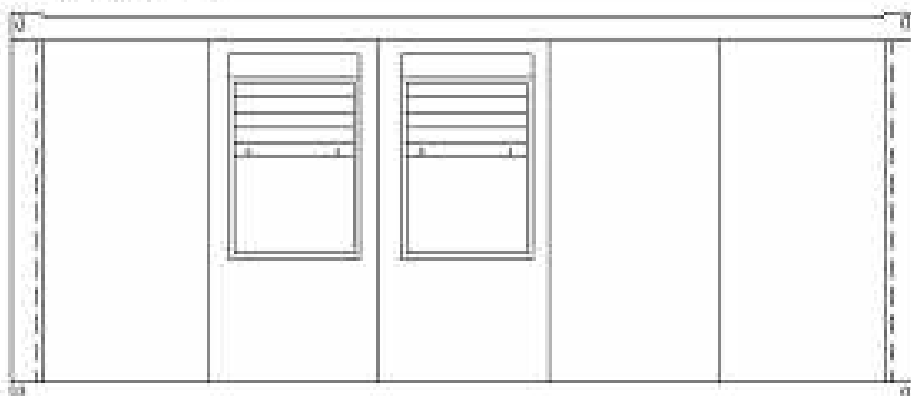

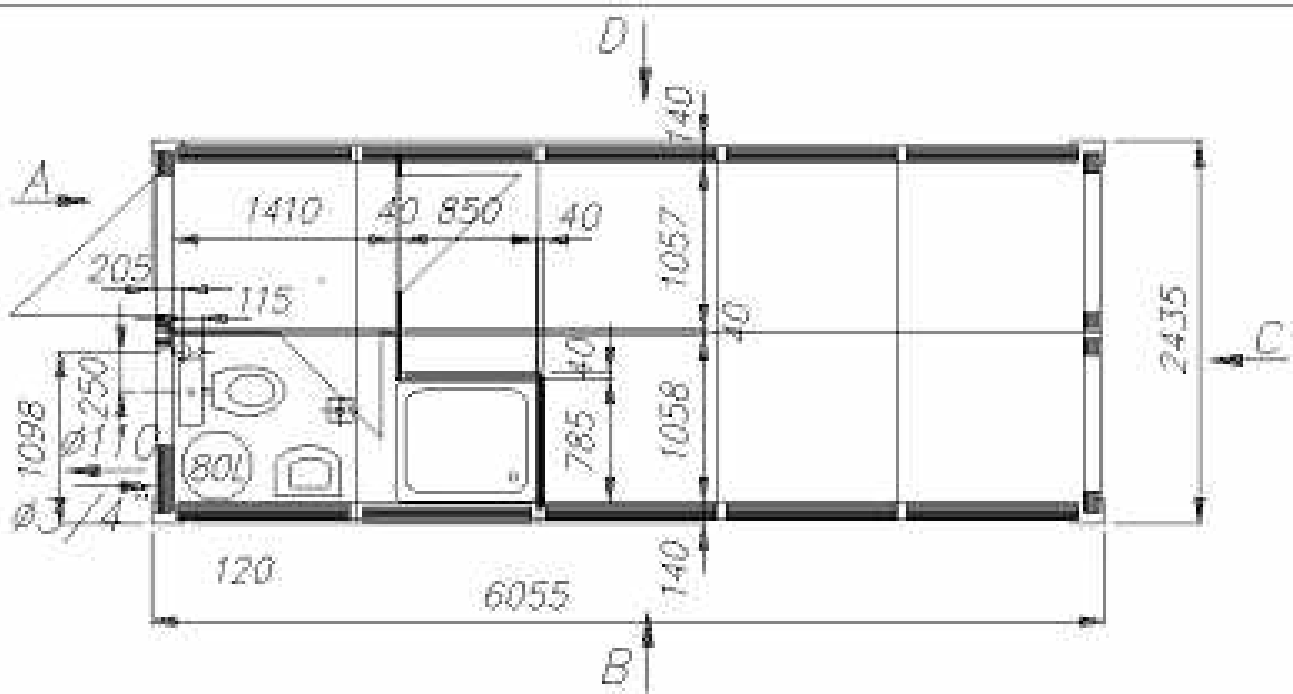

Ansicht A

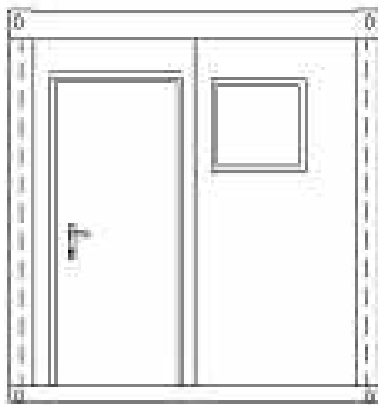

Ansicht B

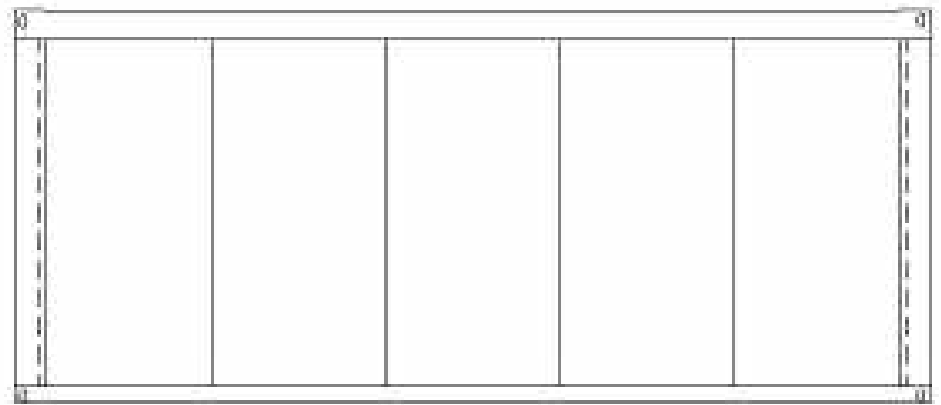

Ansicht C

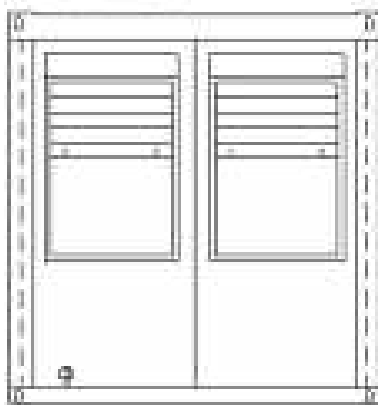

Ansicht D

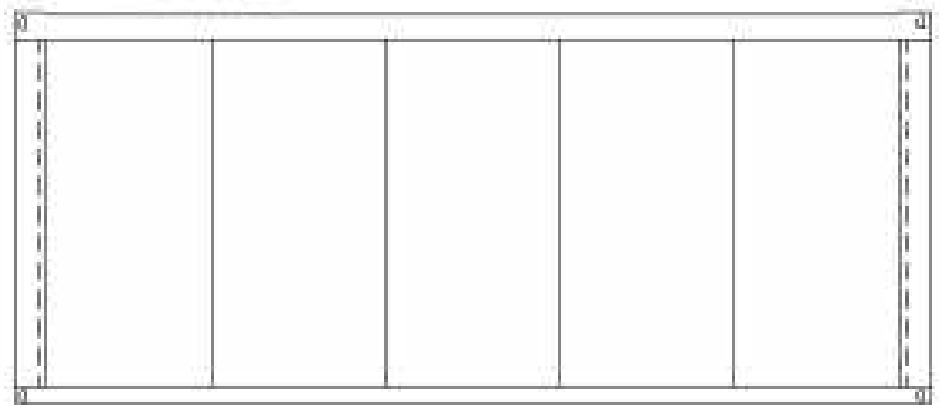

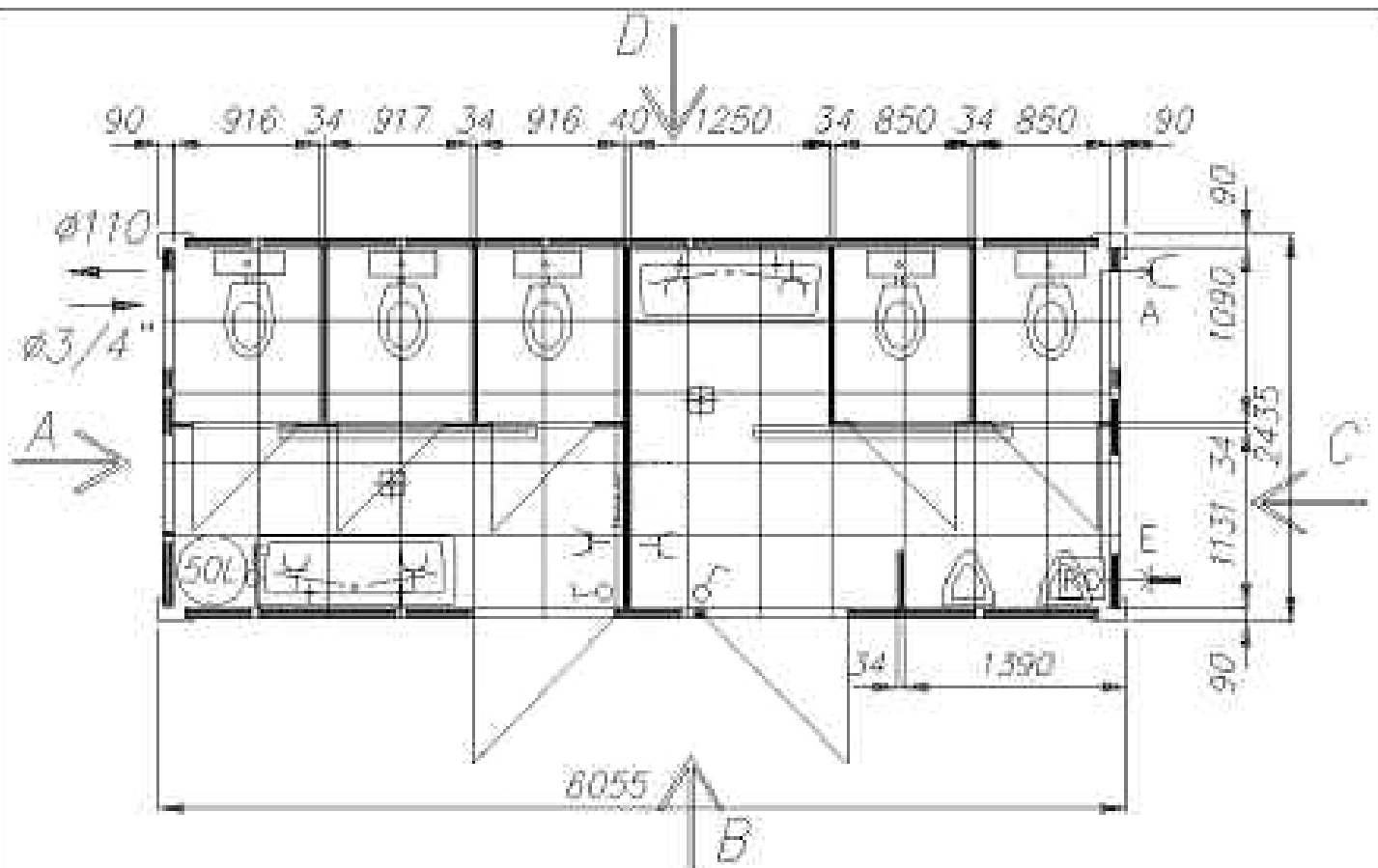

Ansicht A



Ansicht B

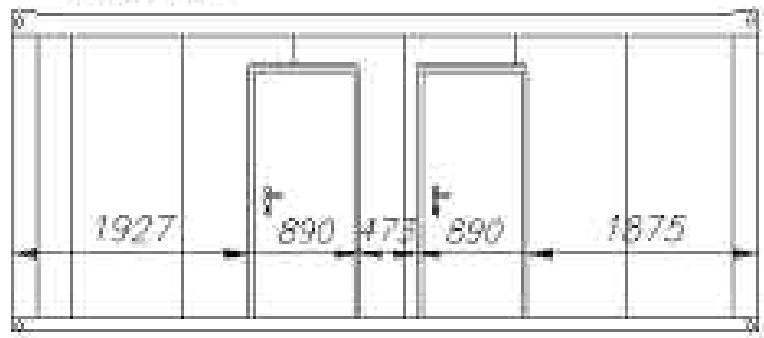

Ansicht C



Ansicht D

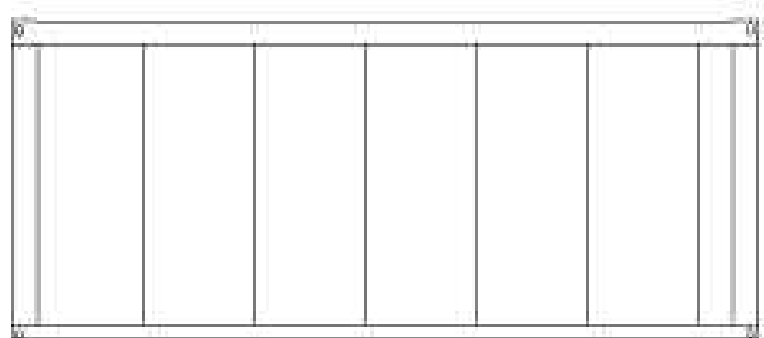

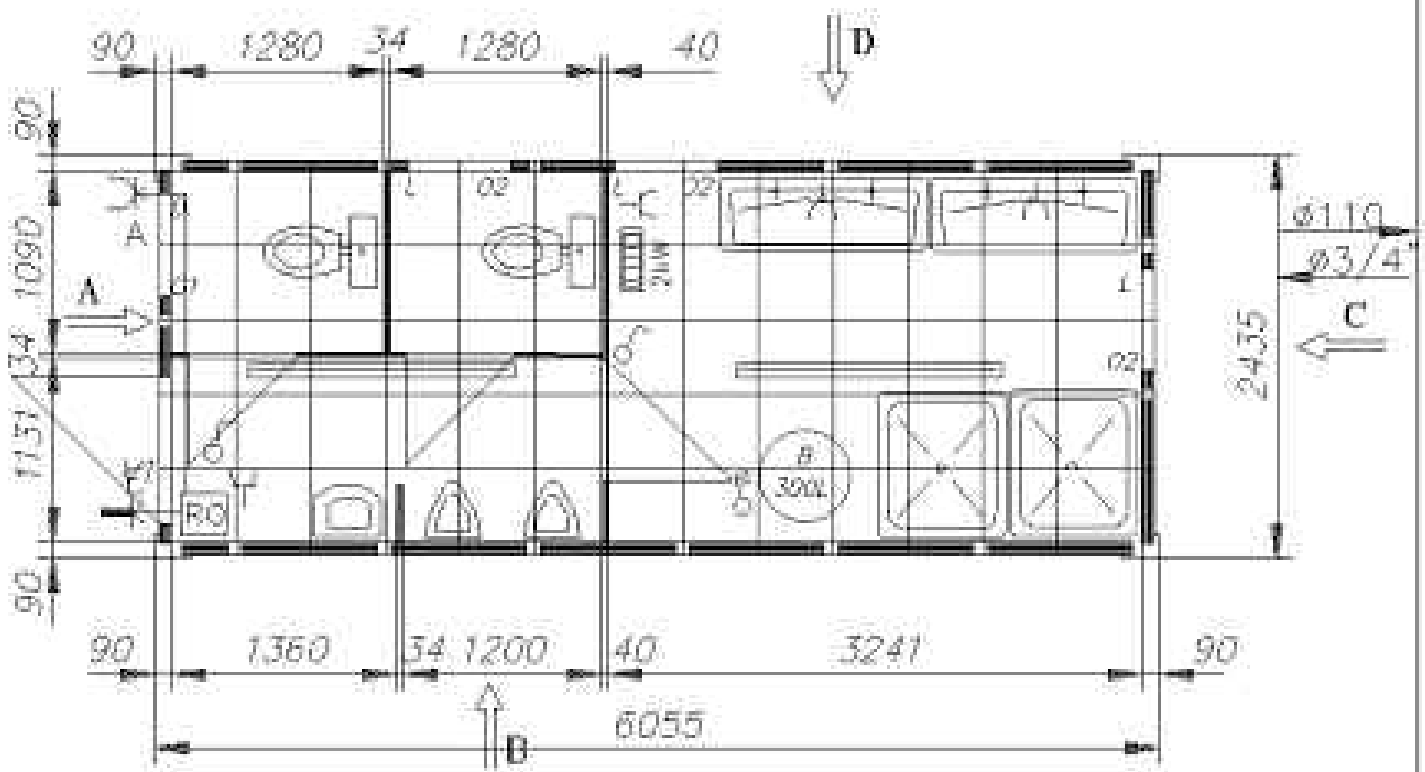

Ansicht A



Ansicht B

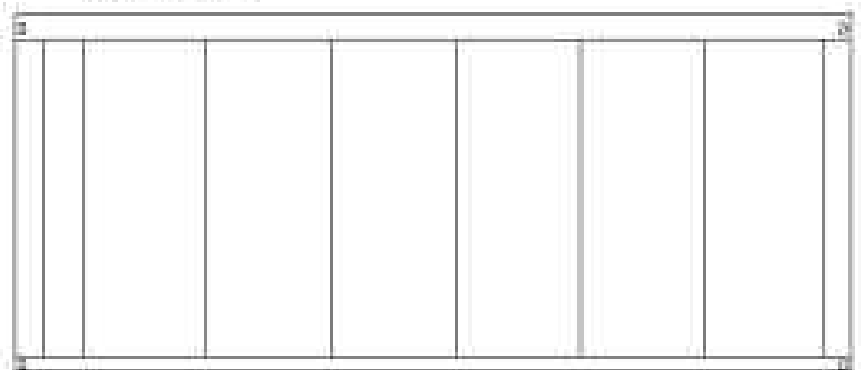

Ansicht C



Ansicht D

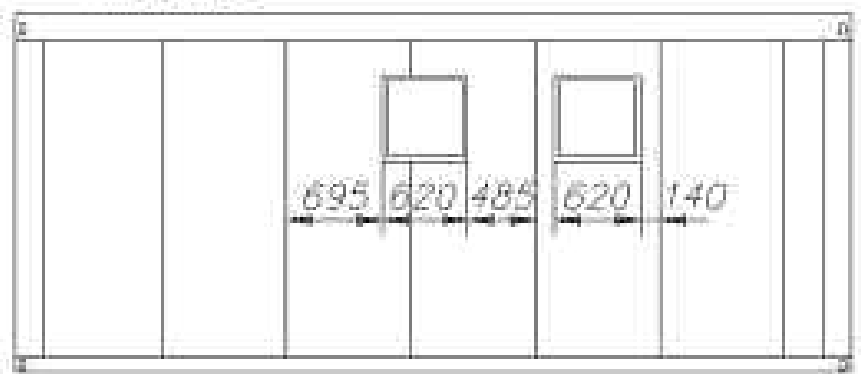

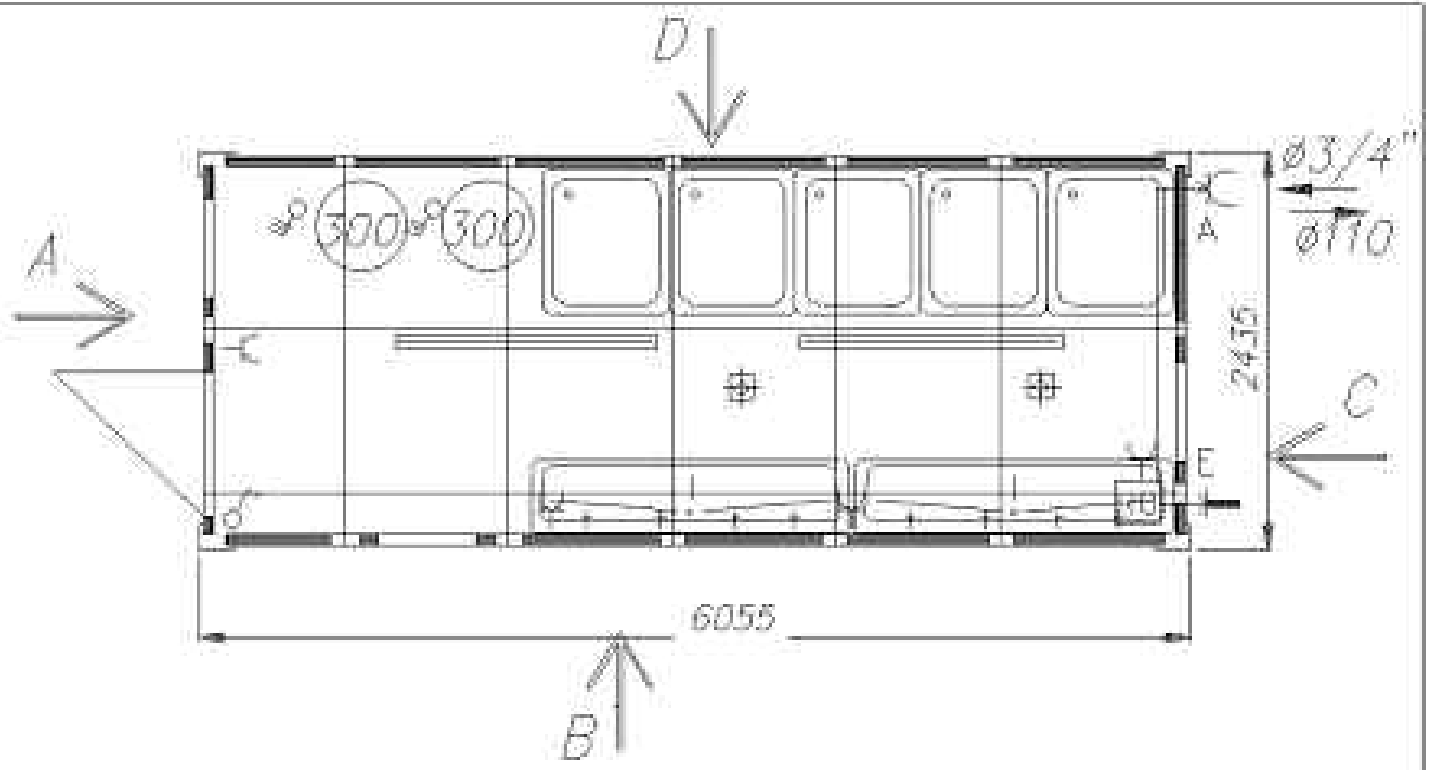

Ansicht A

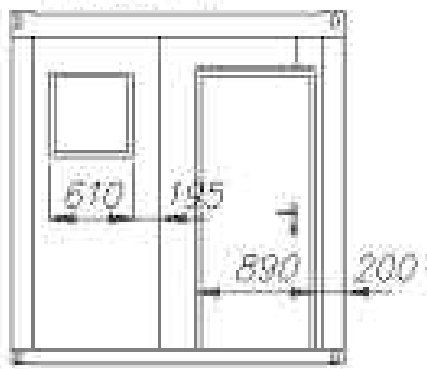

Ansicht B

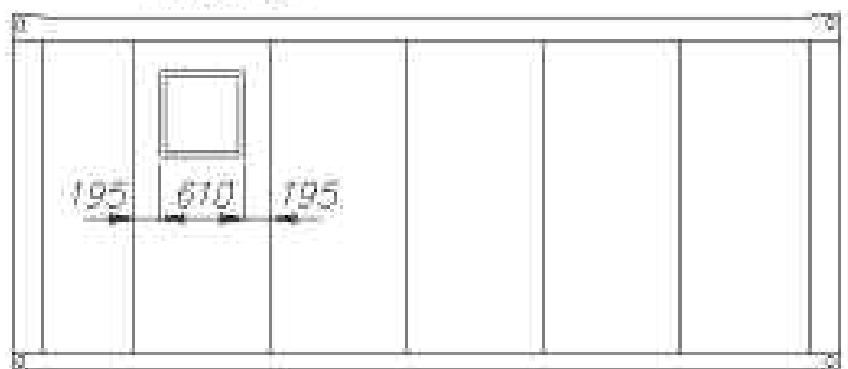

Ansicht C



Ansicht D

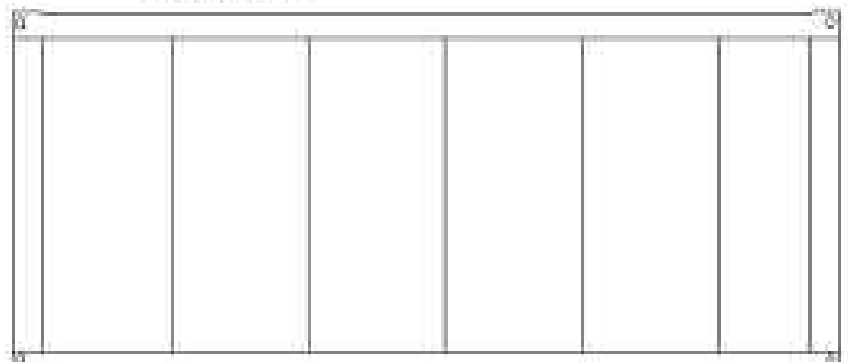



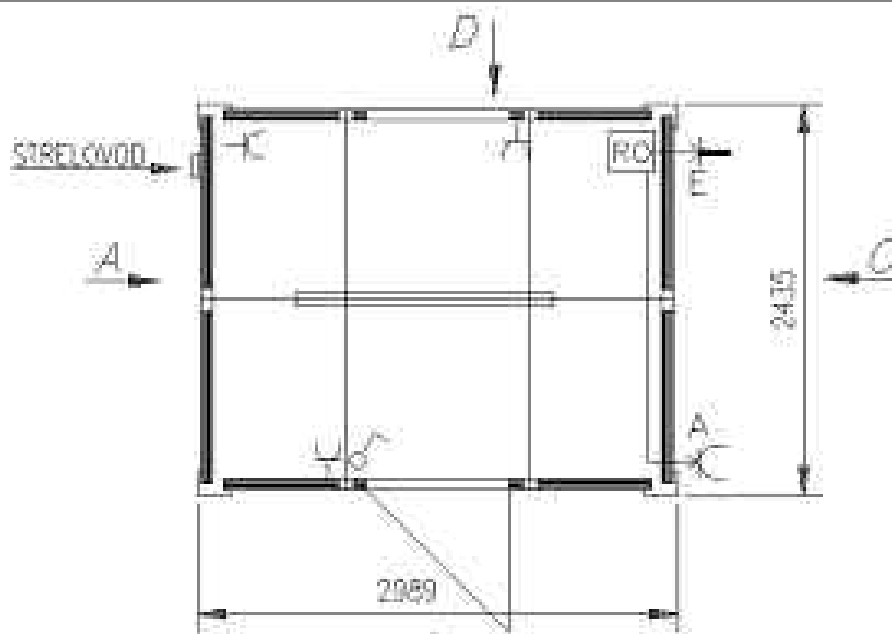

Ansicht A

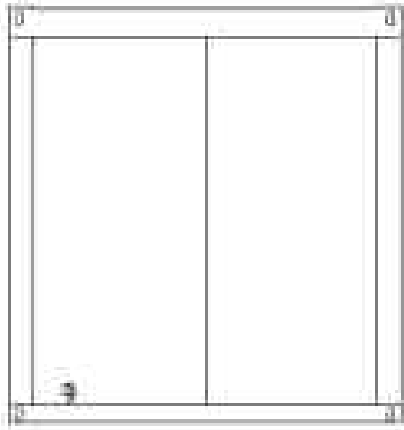

Ansicht B

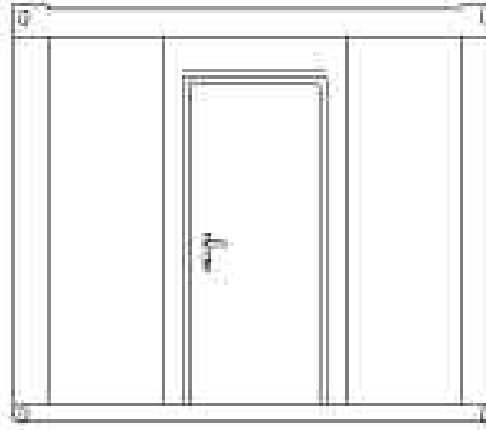

Ansicht C

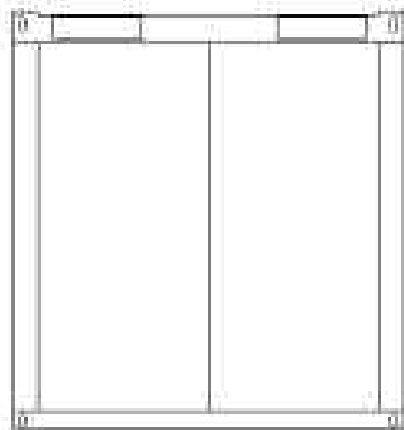

Ansicht D

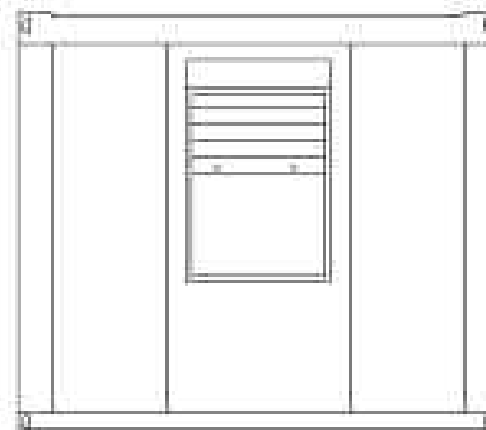

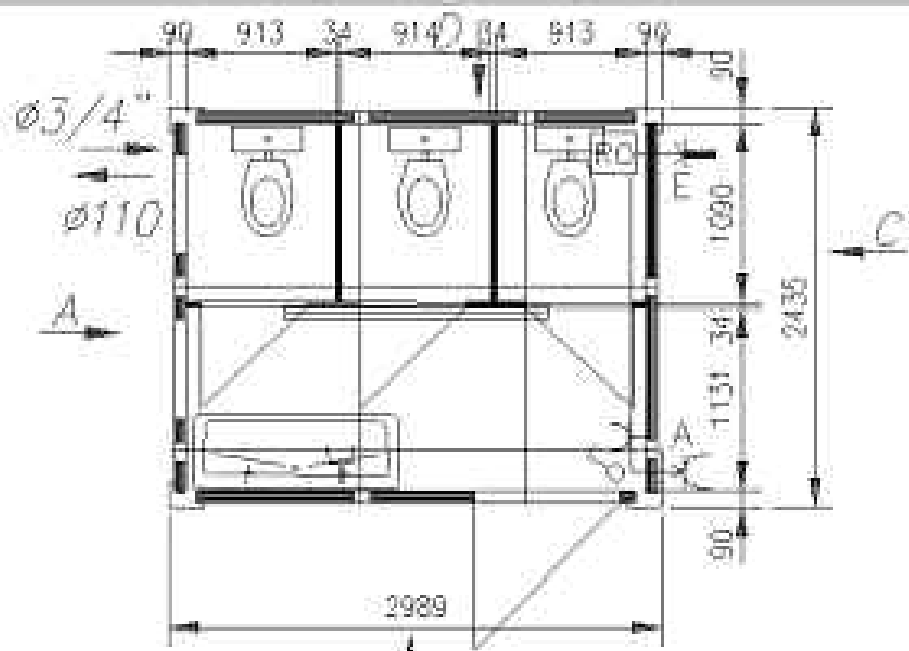

Ansicht A

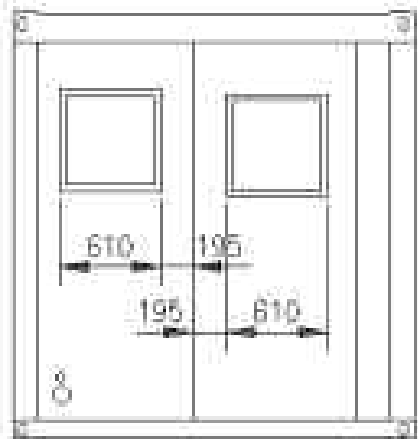

Ansicht B

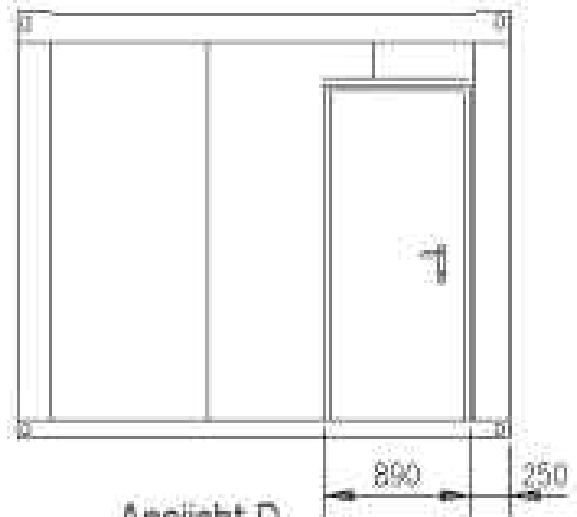

Ansicht C

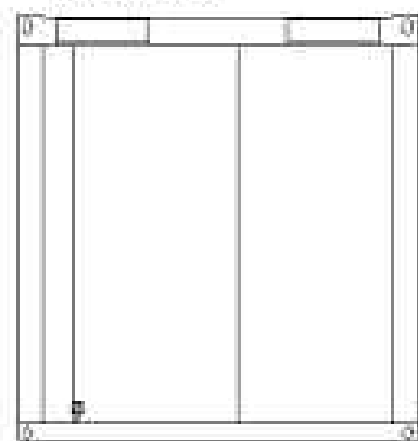

Ansicht D

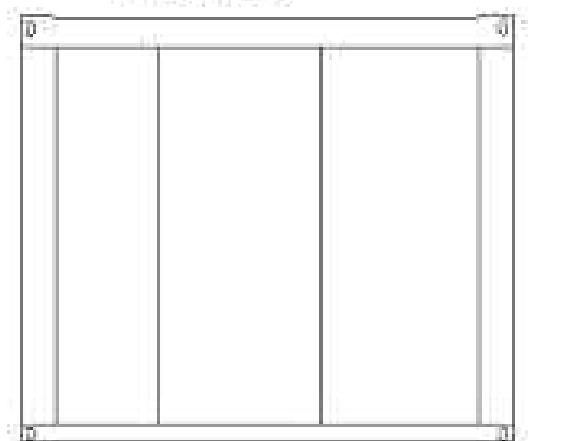

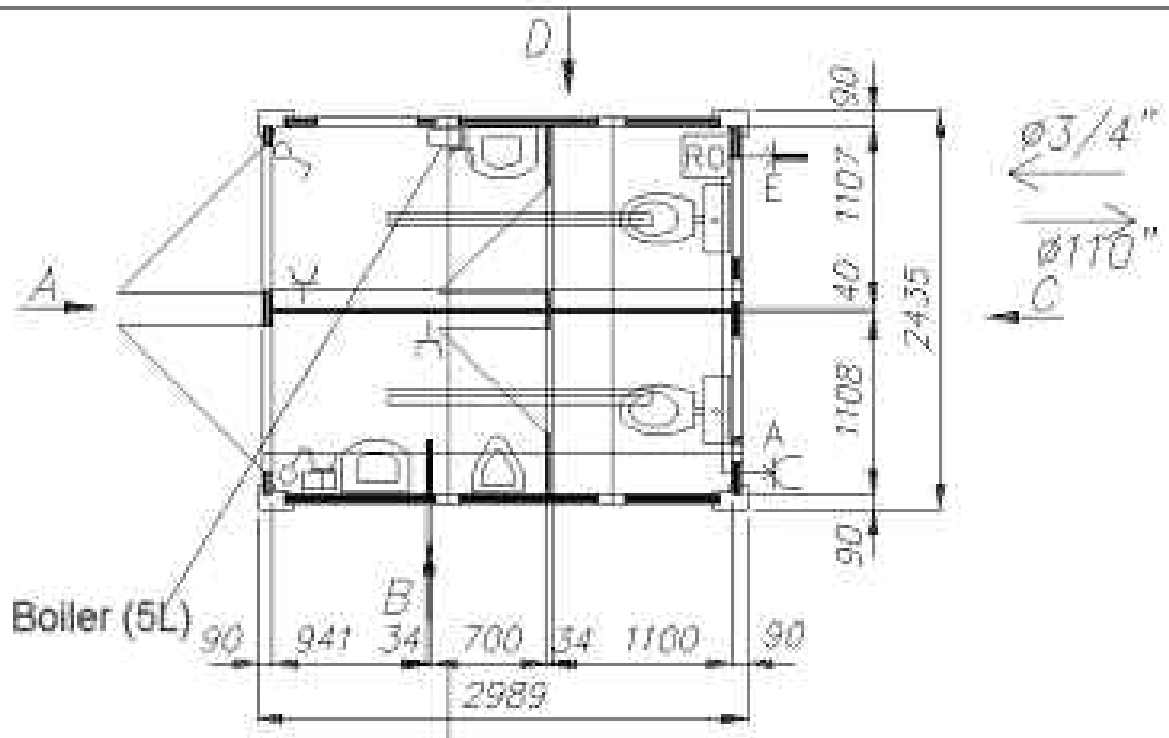

Ansicht A



Ansicht B

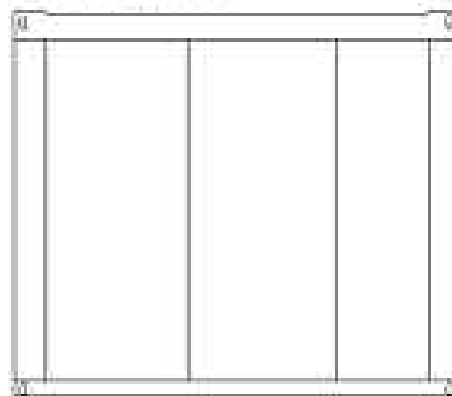

Ansicht C

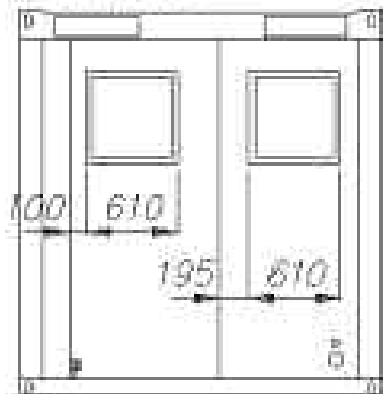

Ansicht D

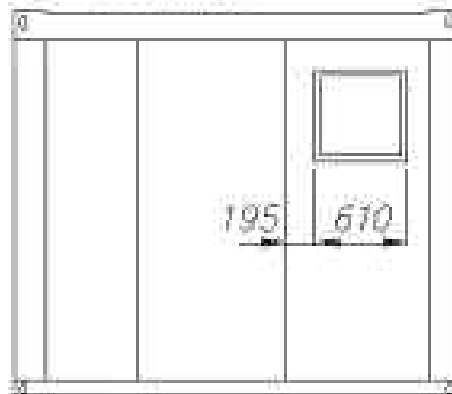

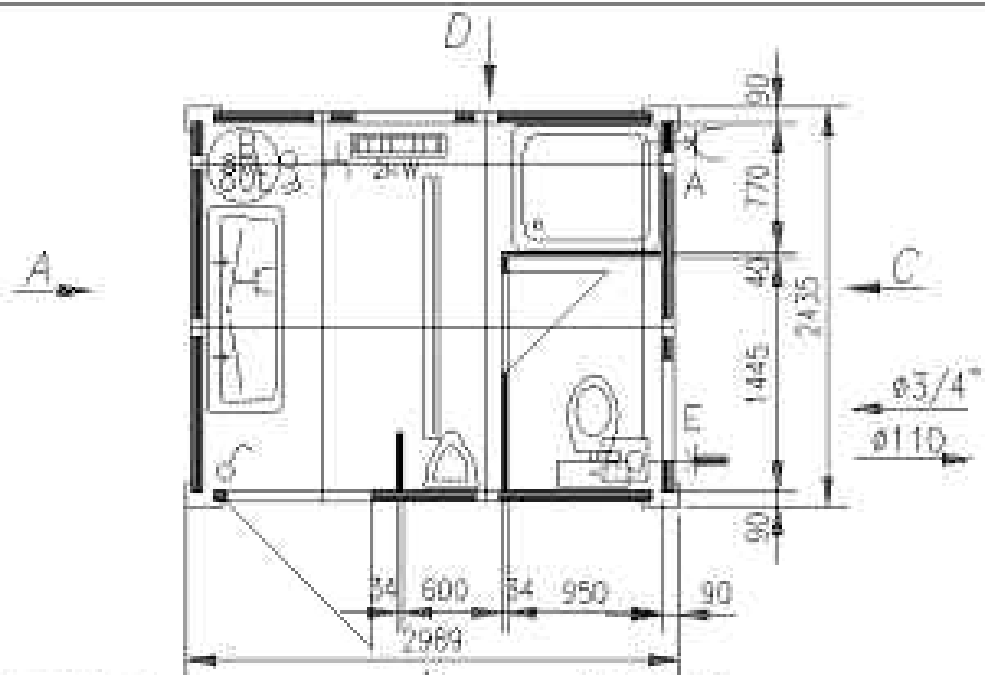

Ansicht A

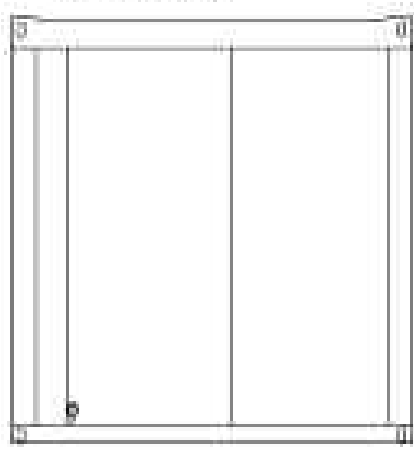

Ansicht B

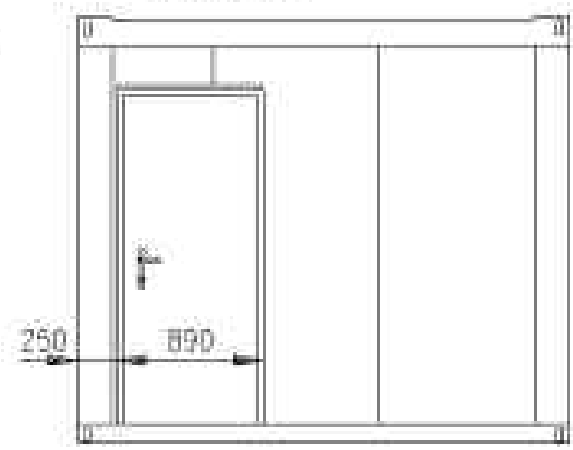

Ansicht C



Ansicht D

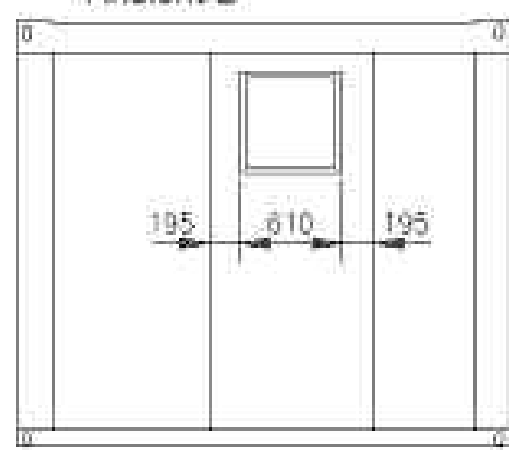

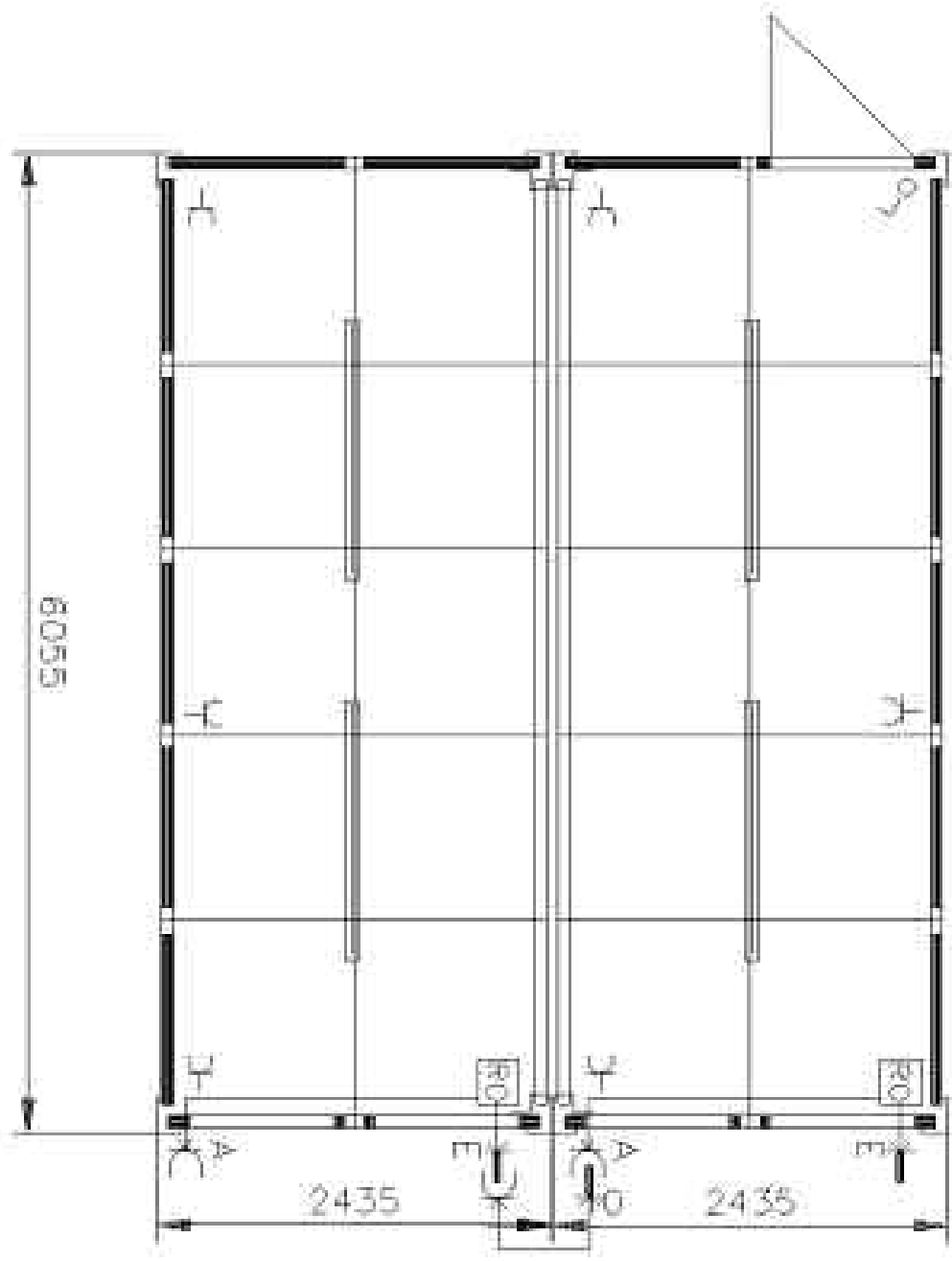

10-11-14

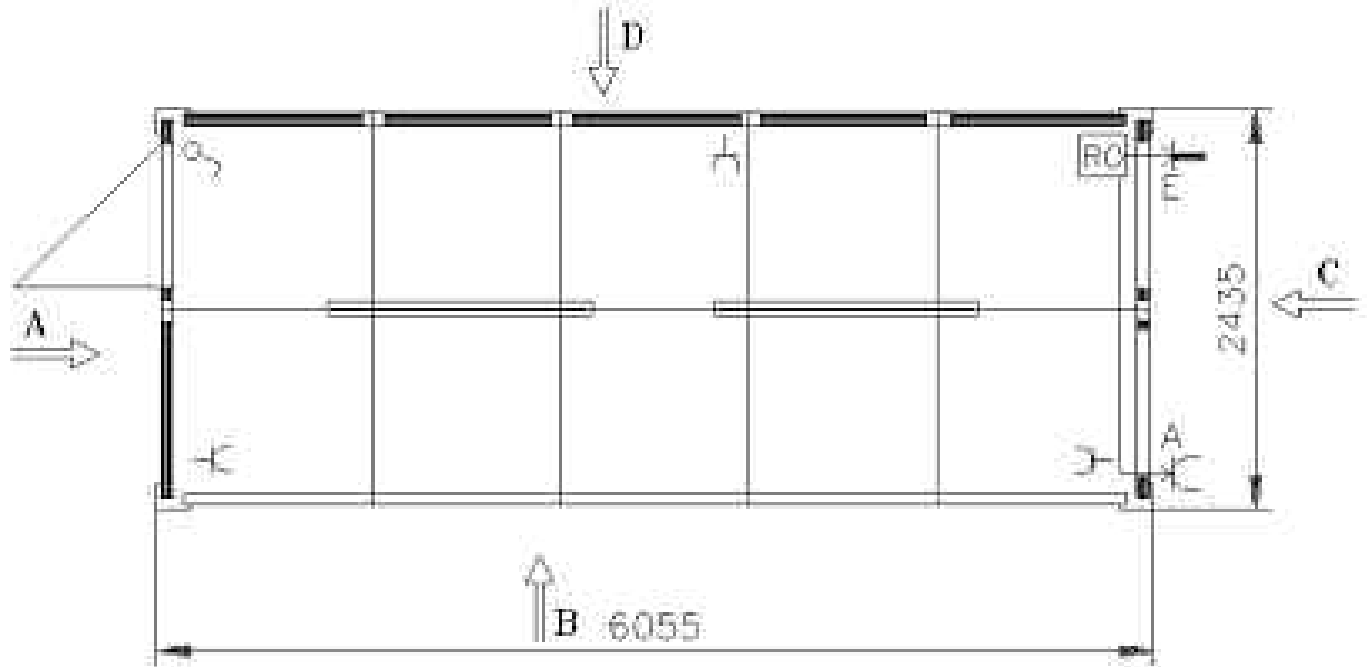

Ansicht A

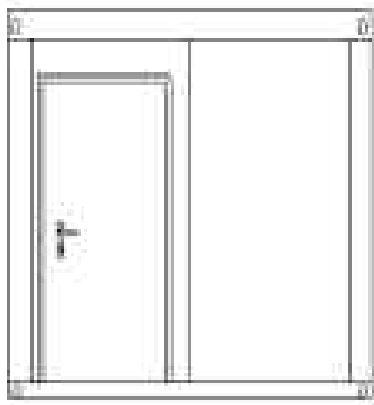

Ansicht B



Ansicht C



Ansicht D

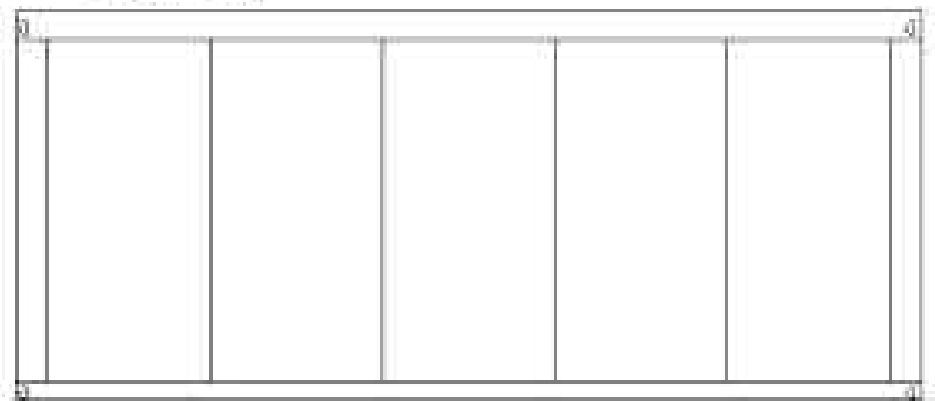

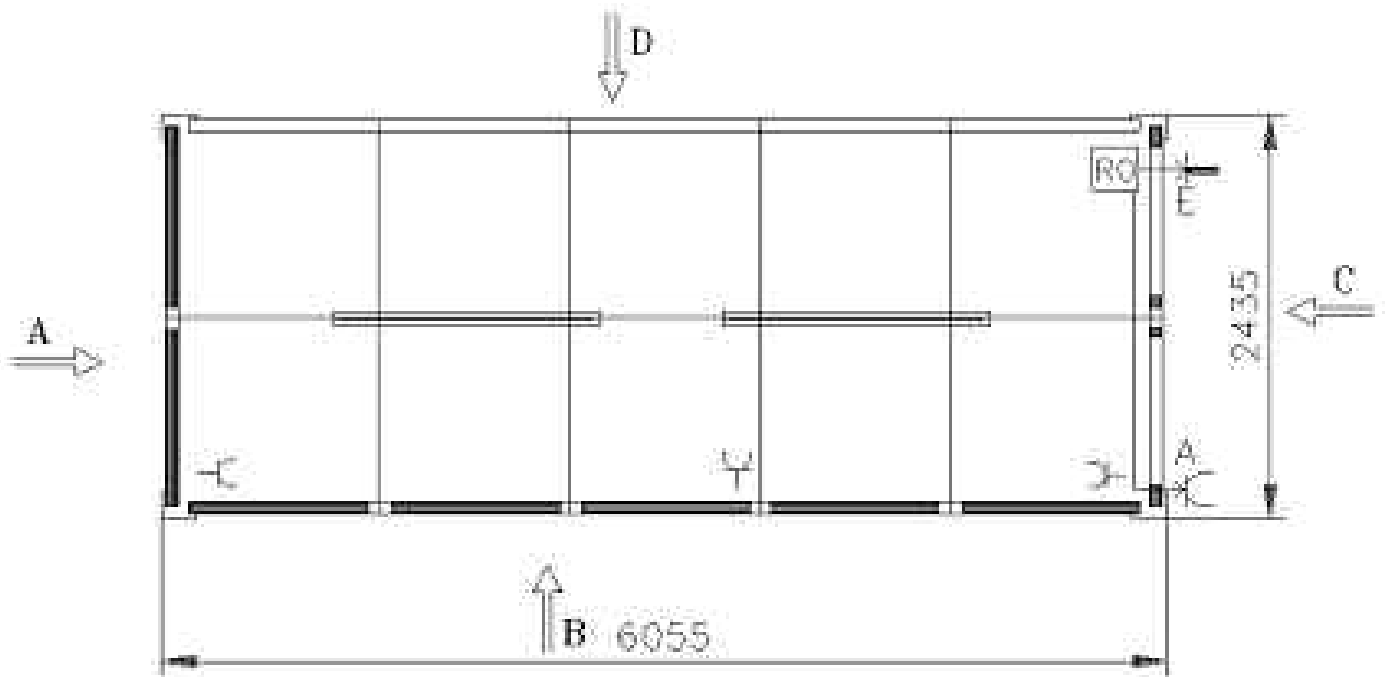

Ansicht A

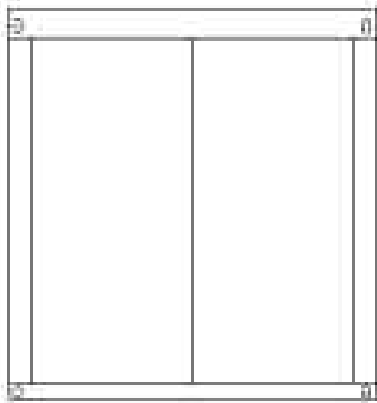

Ansicht B

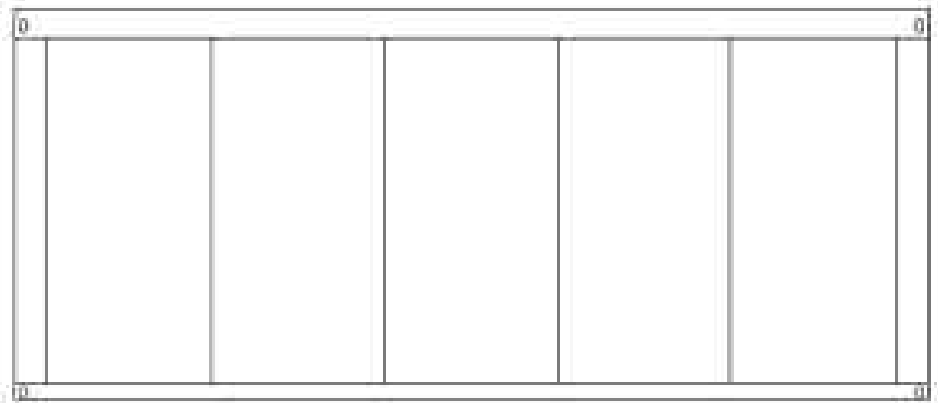

Ansicht C

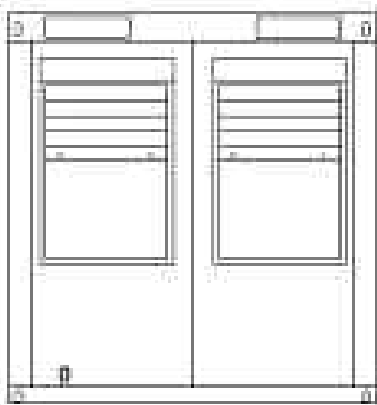

Ansicht D

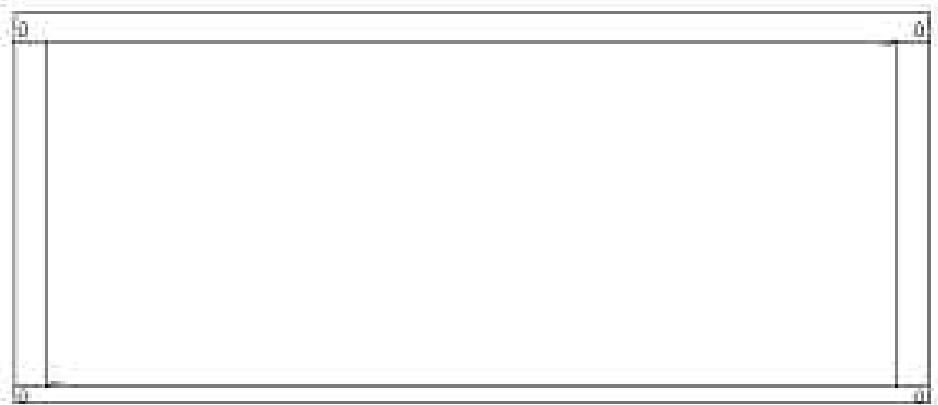

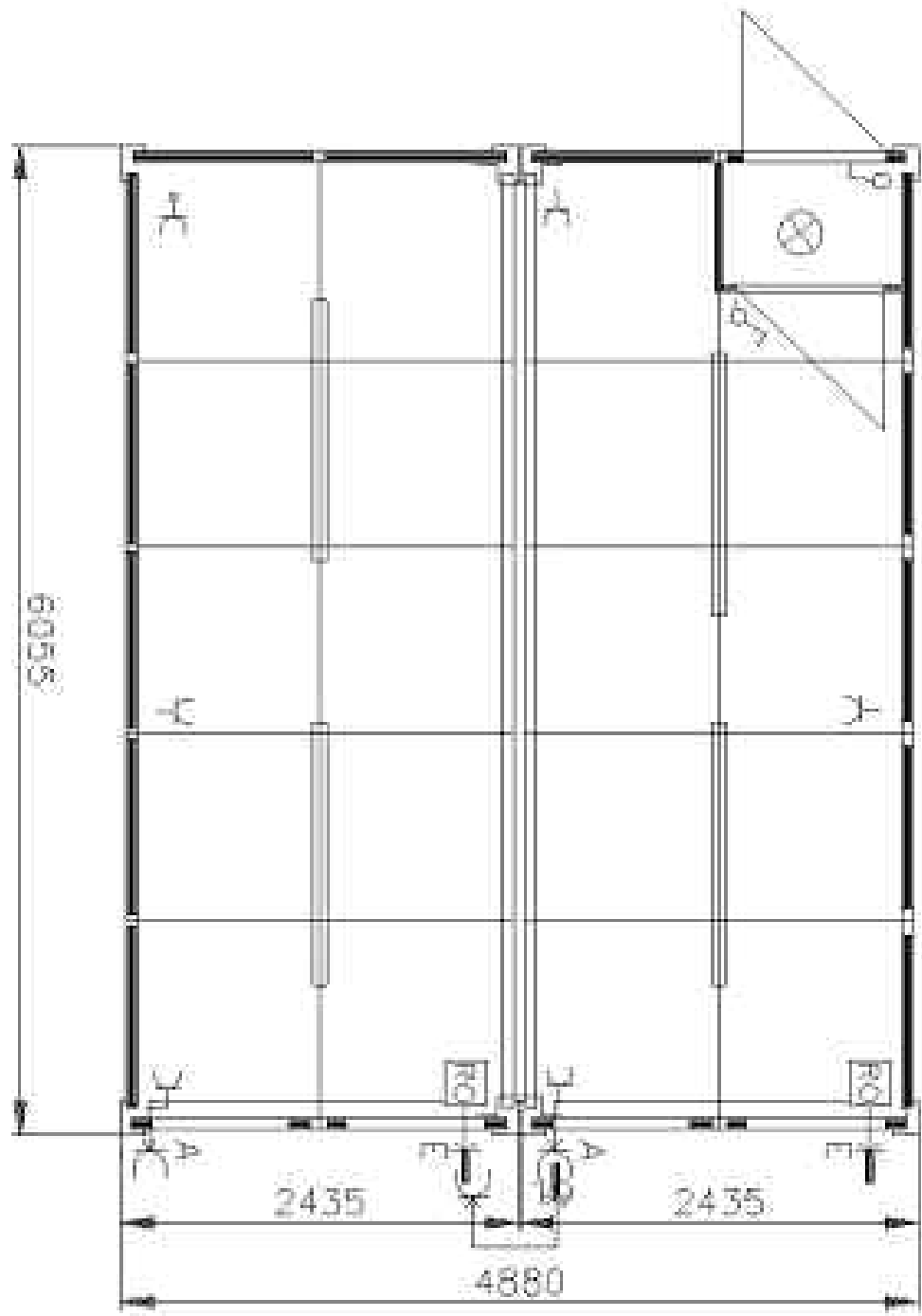



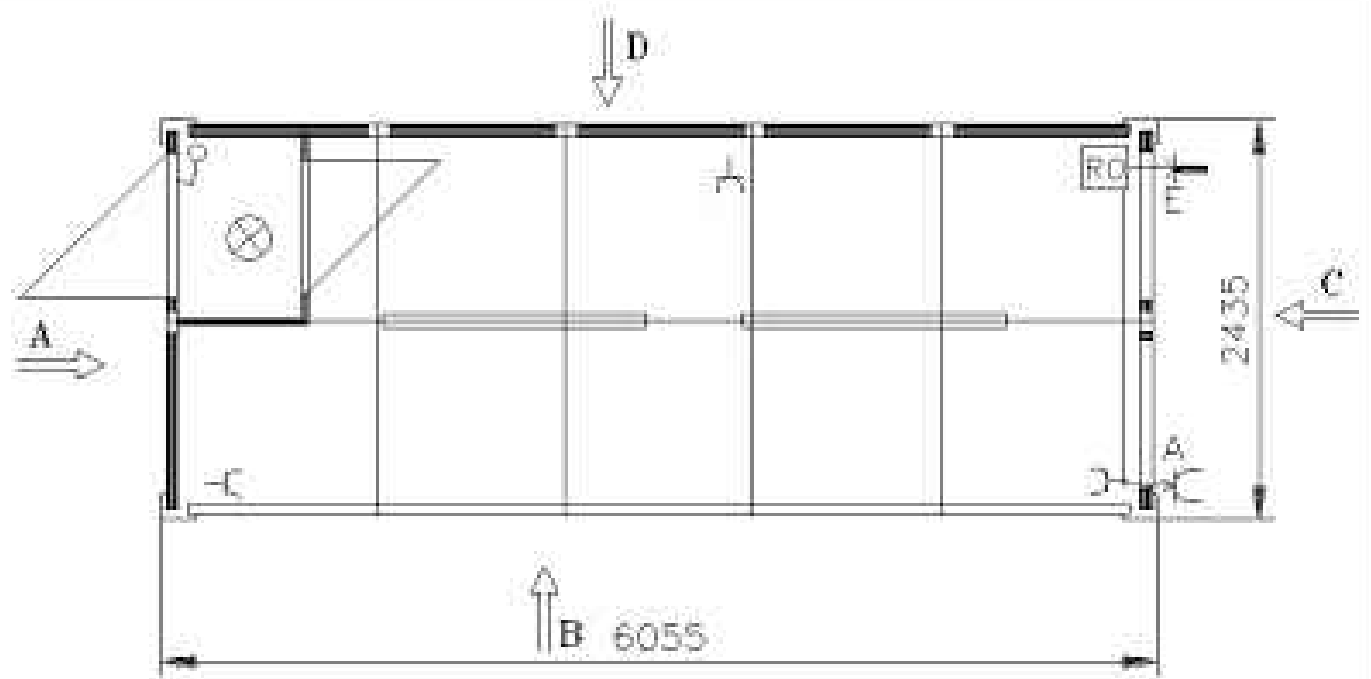

Ansicht A



Ansicht B



Ansicht C



Ansicht D

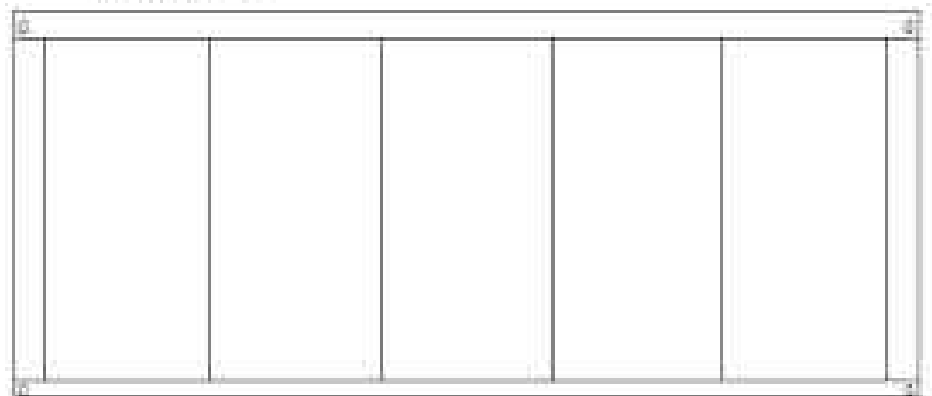

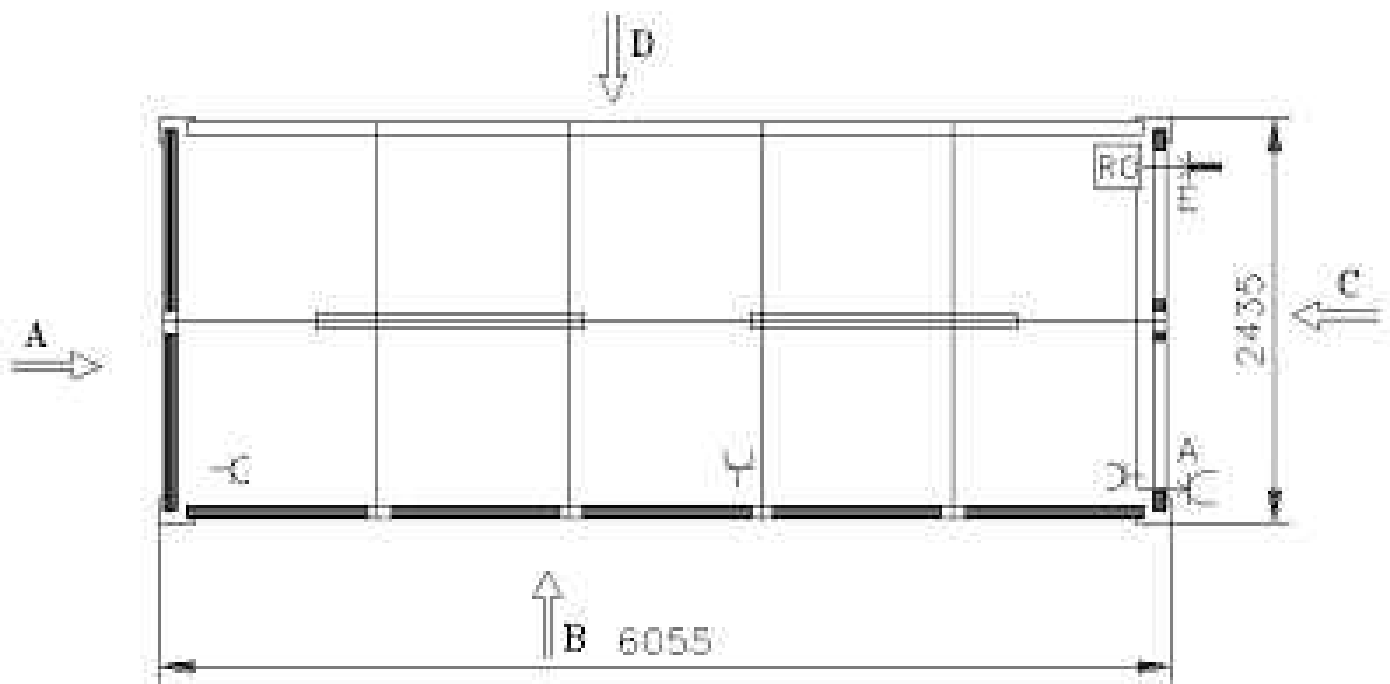

Ansicht A

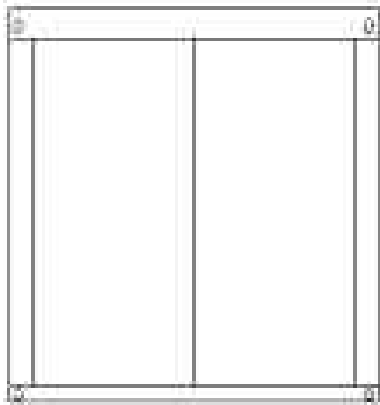

Ansicht B

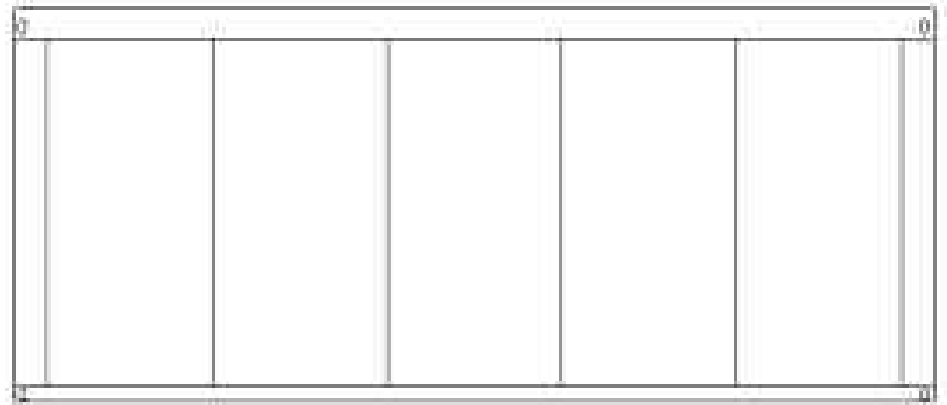

Ansicht C

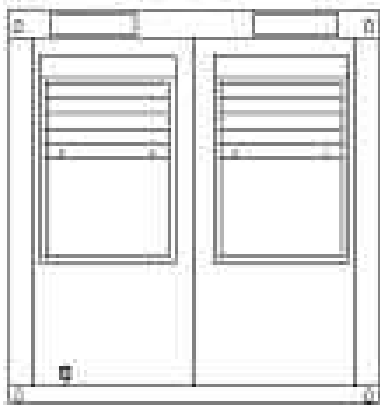

Ansicht D

